



IF YOU CAN DREAM IT
WE CAN MAKE IT

voestalpine Sadef nv

» INLEIDING

» TOEPASSINGEN

- » MODULAIRE UNITS
- » RESIDENTIELE BOUW IN RISICOGEBIEDEN
- » HOOGBOUW STOCKAGE

voestalpine GROEP - WERELDWIJD

- » 5 continenten
- » 50 landen
- » 500 bedrijven
- » 50000 medewerkers wereldwijd



voestalpine Sadef nv

- » Sinds **1947** → meer dan 70 jaar expertise
- » **TEAM** 600 medewerkers Gits-Hooglede
- » **ACTIVITEIT**
 - » Ontwikkeling en productie van montageklare stalen bouwcomponenten
 - » Toepassingen in bouw & voertuigen sector

30 productielijnen voor
stalen profielen op maat



voestalpine Sadef nv

1

ONS PRODUCTIEBEREIK



- » Bandbreedte: 20 tot 1100mm
- » Profielhoogte: tot 305mm
- » Banddikte: 0.4 tot 11mm

ONS PRODUCTIEBEREIK



Meest courante staalsoorten

- » Voorverzinkt staal
- » Voorgelakt staal
- » Inox
- » Aluminium
- » ...



OFFLINE BEWERKINGEN & SERVICE

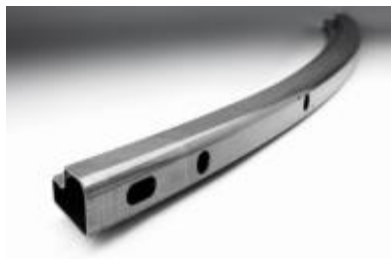

Rolbuigen



Doornbuigen



Persbuigen

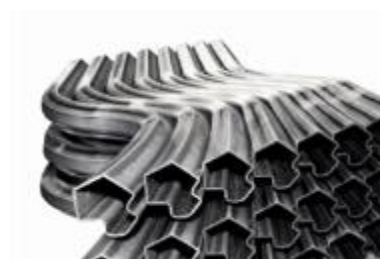

Roldoornbuigen



Speciale verpakking



JIT Levering



Werflevering

ONTWERPONDERSTEUNING / INNOVATIE

- » Eigen team 25 ingenieurs bouwkunde :
 - » Co-engineering
 - » Projectgebonden ontwerpen
 - » Ondersteuning ingenieursburo's

» Ontwerptools voor klanten : **iInnovate.**

iDraw. iDetail. iPurlin. iSolar.

KLANTSPECIFIEKE PROFIELVORMEN



- » Klantspecifieke perforaties
- » Intelligente verbindingen

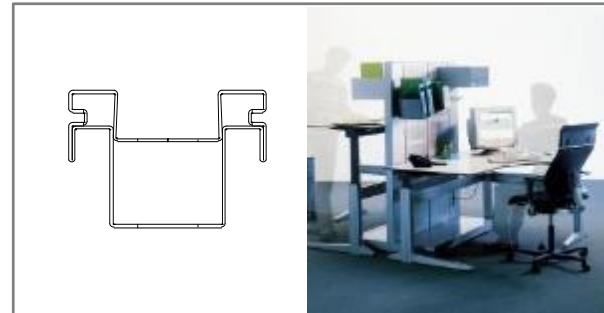
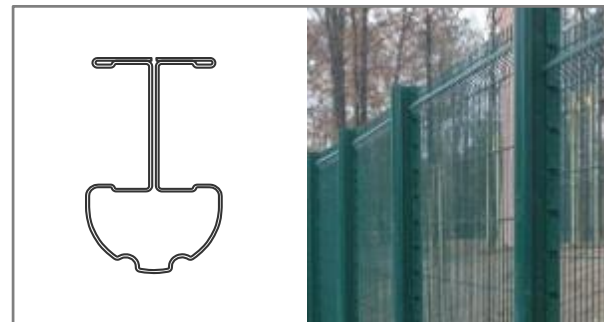

KLANTSPECIFIEKE PROFIELVORMEN

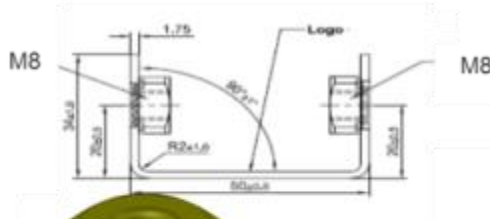
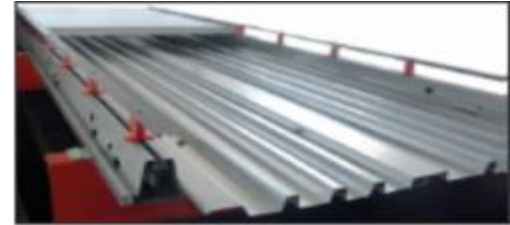
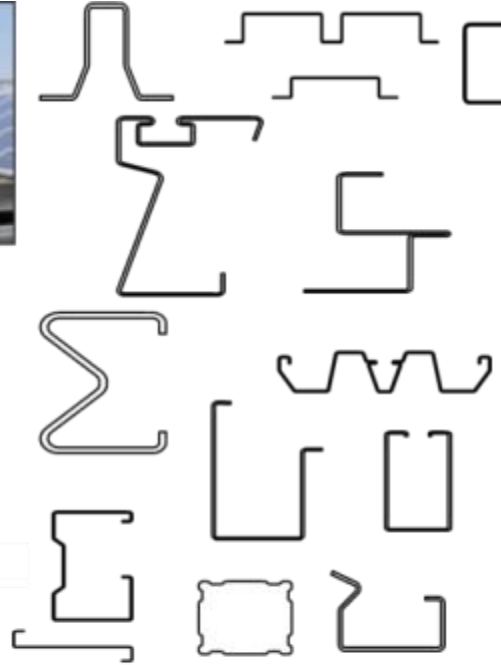

CARPORT MODULAIR SYSTEEM



- » Staal is sterk
- » Gerolvormd is functioneel
- » Gerolvormd is lichter & sneller te monteren
- » Rolvormproces is nauwkeurig → precisie
- » Hoge staalkwaliteiten gemakkelijk inzetbaar
- » Oppervlaktebehandeling reeds geïntegreerd.



SOLAR FARMS

MODULAIRE SYSTEMEN

- » 72 MW-280.000 zonnepanelen- 88ha
- » Engineering-productie & montage = 3 maand
- » Snelproductie & snelbouw systeem
- » Gerolvormde stalen bouwsysteem :
 - » Lichtheid & vrije vormgeving van aluminium
 - » Sterkte van staal
- » Competitieve totaaloplossing

SOLAR FARMS



MODULAIRE SYSTEMEN

- » Compleet in gerolvormde stalen profielen
- » Inschuifstelsel : 5x sneller
- » Insertmoeren en -bouten in profiel
- » Hoogwaardige oppv.behandeling
 - » 25 jr garantie C4 omgeving



voestalpine Sadef nv

» Inleiding

» Toepassingen

- » MODULAIRE UNITS
- » RESIDENTIELE BOUW IN RISICOGEBIEDEN
- » HOOGBOUW STOCKAGE

MODULAIRE UNITS

CO-ENGINEERING & PROTOTYPING

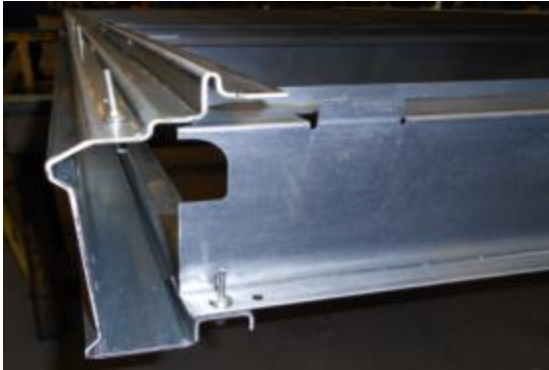

MODULAIRE UNITS

VLOERFRAMES MET GEÏNTEGREERD VERBINDINGEN

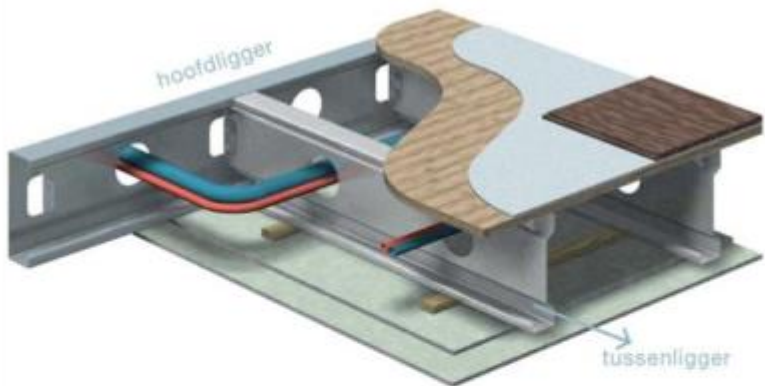

- Dunwandige profielen tot 450mm hoog
Licht en economisch
- ACM-systeem (Auto Connect Middle)
Snelle montage dankzij geïntegreerde verbindingen

AutoConnectEnd (ACE)

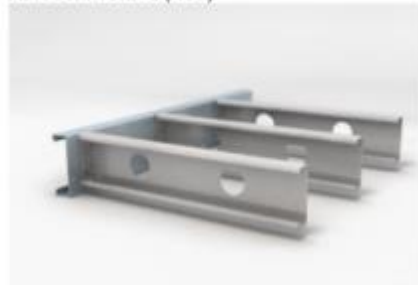

DETAIL

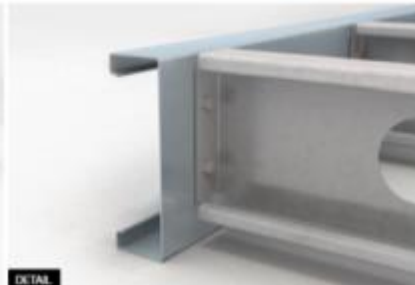

AutoConnectMiddle (ACM) + AutoNotch (AN)



DETAIL



voestalpine Sadef nv

19 | 14/11/2017 | Industrialisatie van de bouw

voestalpine

ONE STEP AHEAD.

MODULAIRE UNITS

SNEL LEVERBAAR STANDAARD SYSTEEM



L=6m
B=3m
H=3m

➤ BUILDING CONFIGURATIONS

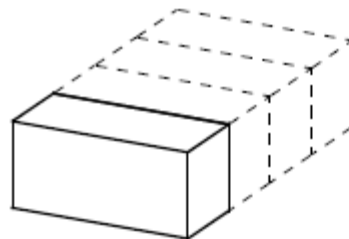

Fig. 2. Ground floor.

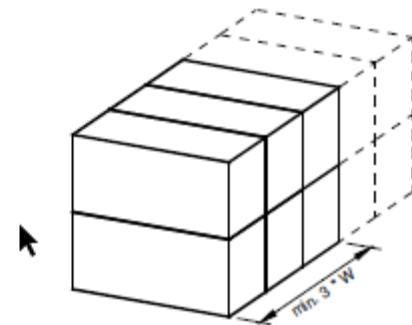

Fig. 3a. Two floors building bloc.



MODULAIRE UNITS

SNEL LEVERBAAR STANDAARD SYSTEEM

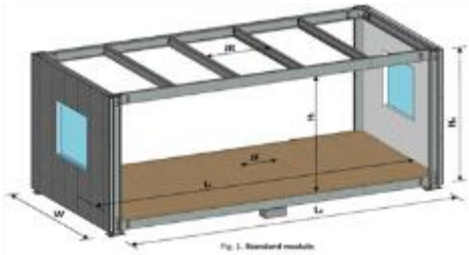

Fig. 1. Standard module



Fig. 3b. Two floors building bloc.

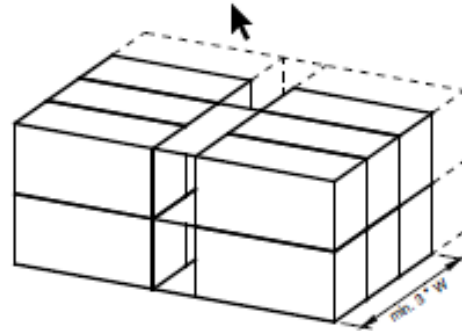
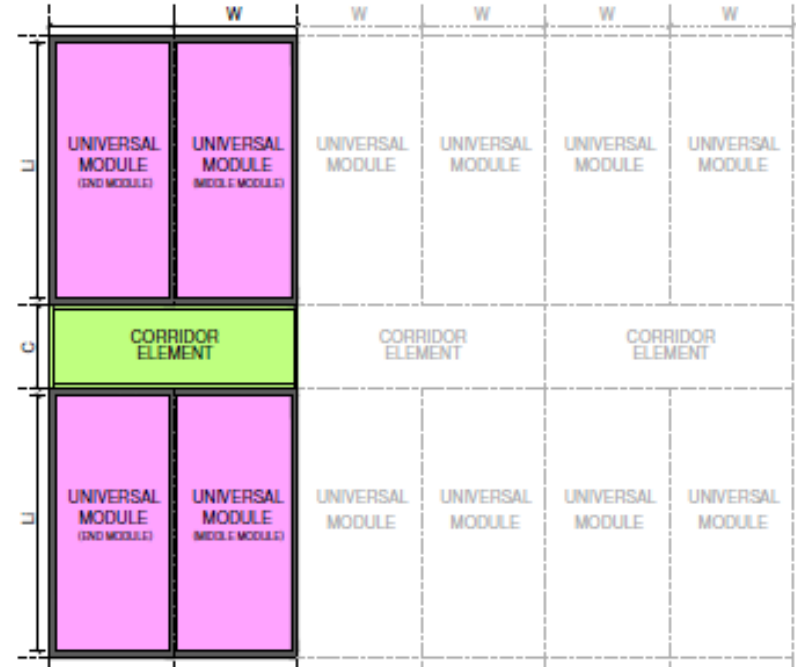

Fig. 5. Building bloc with central corridor.



voestalpine

ONE STEP AHEAD.

MODULAIRE UNITS

SNEL LEVERBAAR STANDAARD SYSTEEM



voestalpine
ONE STEP AHEAD.

MODULAIRE UNITS

HOUSE OF INNOVATION

SADEF
BUILDING PRODUCTS



voestalpine Sadef nv

23 | 14/11/2017 | Industrialisatie van de bouw

voestalpine
ONE STEP AHEAD.

MODULAIRE UNITS

OPTOPPEN



» Uitbreiding 6 woningen

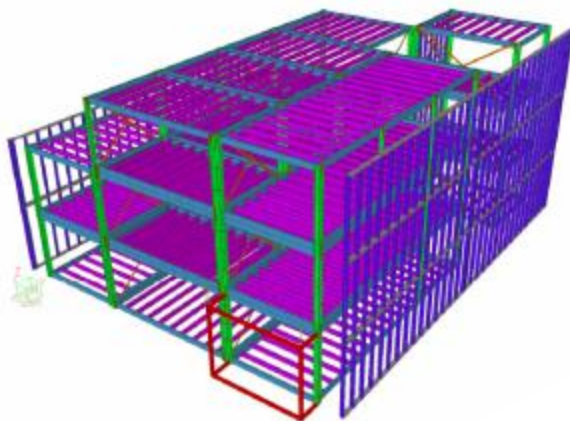

MODULAIRE UNITS

OPTOPPEN

SADEF
BUILDING PRODUCTS



voestalpine Sadef nv

» Inleiding

» Toepassingen

- » MODULAIRE UNITS
- » RESIDENTIELE BOUW IN RISICOGEBIEDEN
- » HOOGBOUW STOCKAGE

RESIDENTIELE BOUW IN RISICOGEBIEDEN

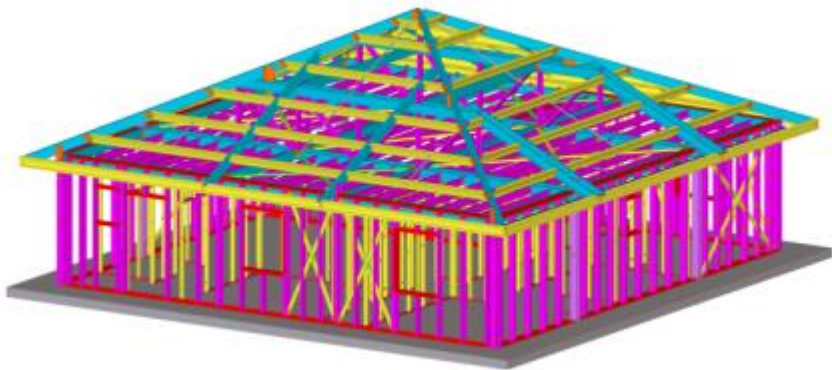

- » Pre-engineered woningbouw systeem
- » Cycloonwind bestendig (300km/u)
- » Regio Caraïben
- » Licht, snel , duurzaam bouwen
- » Toelevering stalen mecano bouwpakket
- » Engineering door voestalpine Sadef



RESIDENTIELE BOUW IN RISICOGEBIEDEN

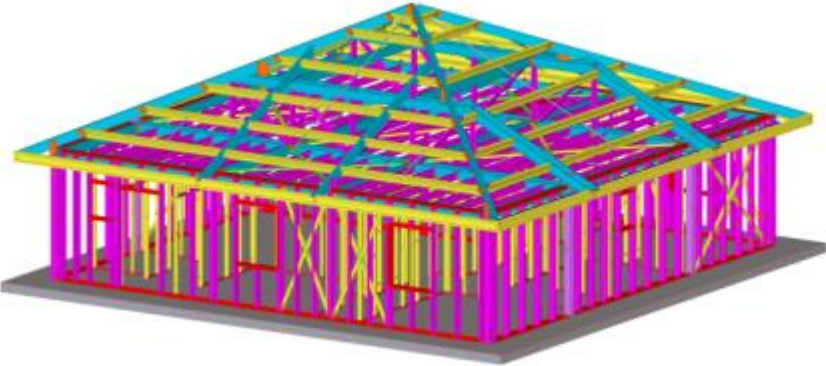

RESIDENTIELE BOUW

IN RISICOGEBIEDEN



- » Pre-engineered bouwsteembouw
- » Appartementen/hotels
- » Cycloonwind bestendig
- » Seisme bestendig
- » Regio Caraïben
- » Licht, snel , duurzaam bouwen
- » Primaire structuur : HEA kolommen + gerolvormde vloersystemen.
- » Realisatie Punta Cana

RESIDENTIELE BOUW IN RISICOGEBIEDEN

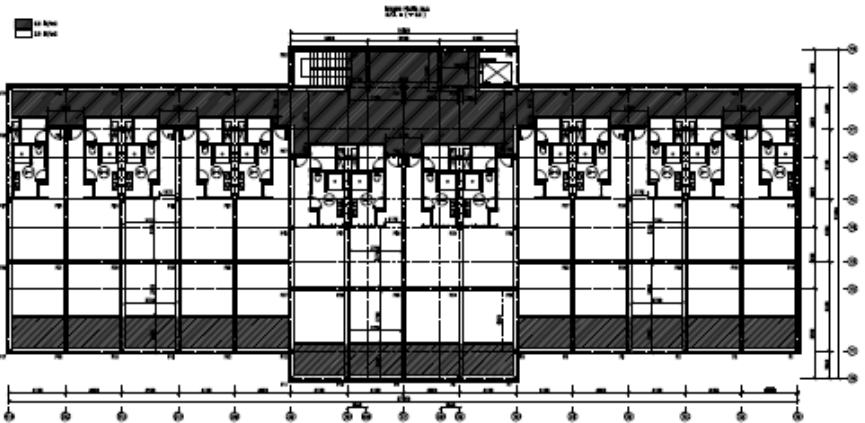
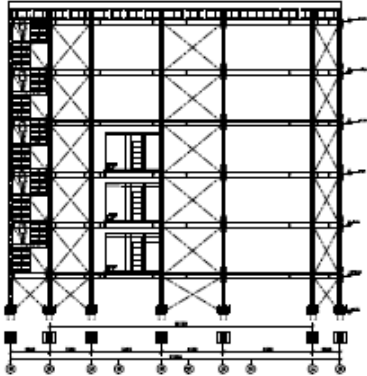
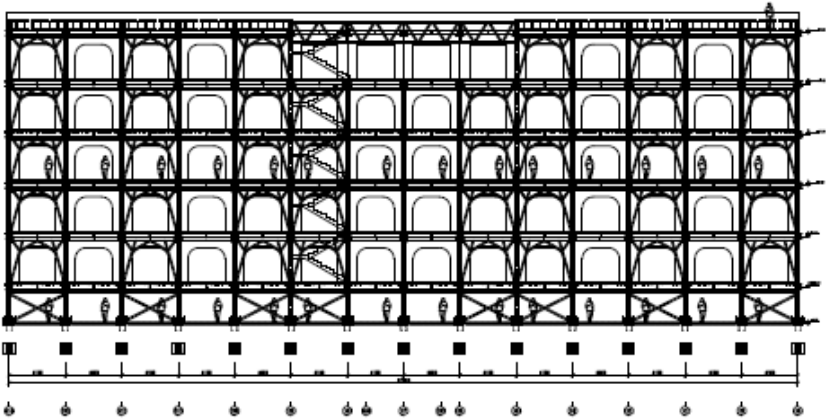

RESIDENTIELE BOUW IN RISICOGEBIEDEN

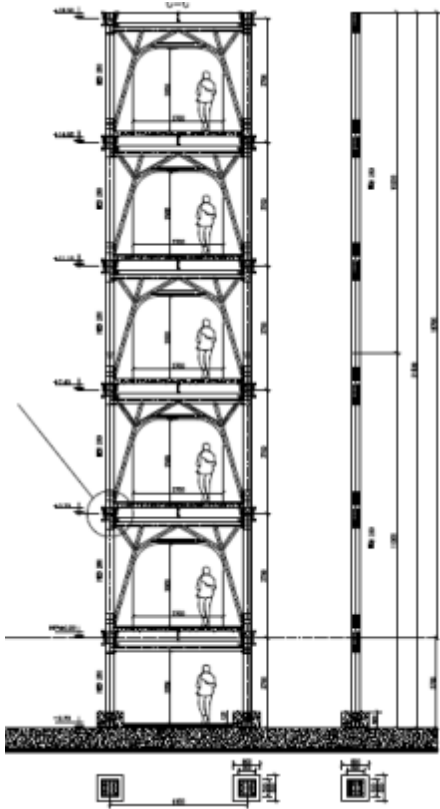

ALZADO G-G

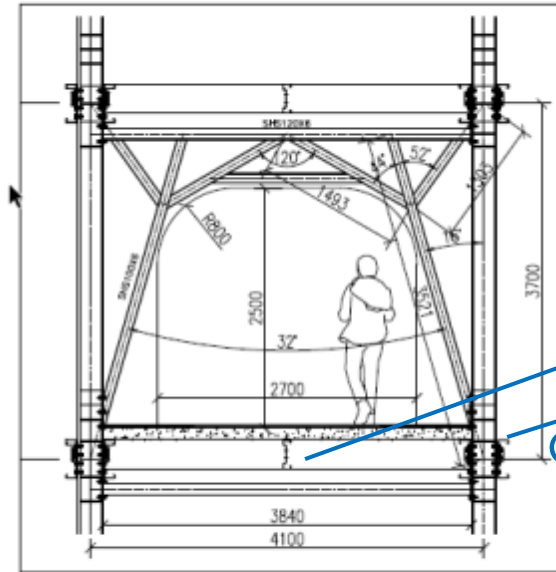

S+300

C+400

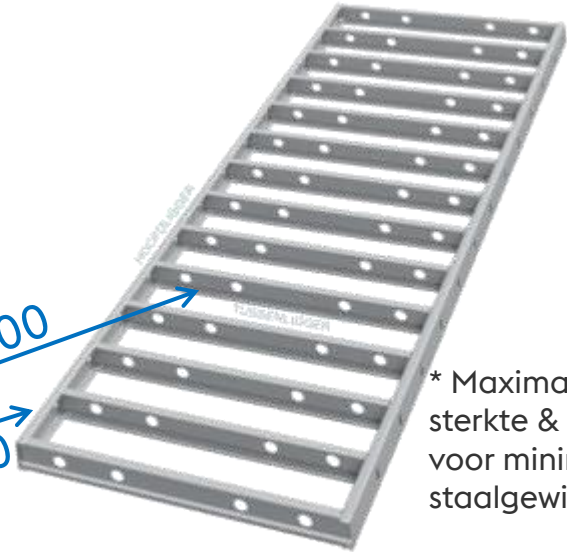

* Maximale sterkte & stijfheid voor minimaal staalgewicht

* Geïntegreerde verbindingen

| | |
|----------------|---------------------------|
| PROEVEN | PLANO FABRICACION |
| IDENTIFICACION | ALZADO G-G - SANCTUARY RD |
| USO | HOTEL SANCTUARY RD |

RESIDENTIELE BOUW

VLOERFRAMES MET GEÏNTEGREERD VERBINDINGEN

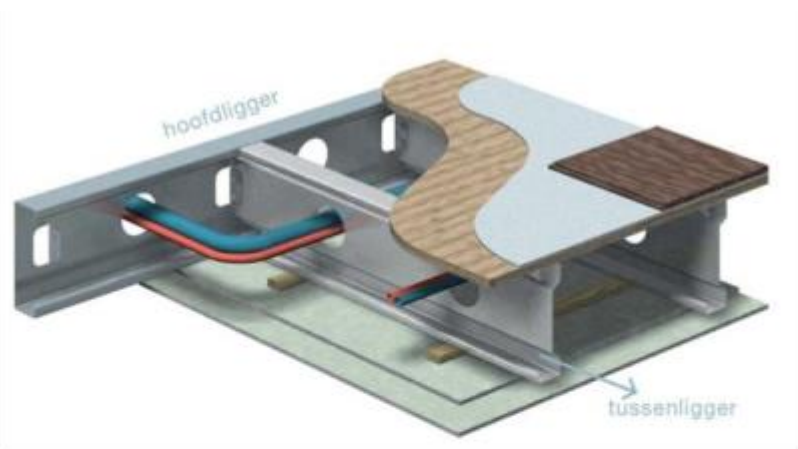

- Dunwandige profielen tot 450mm hoog
Licht en economisch
- ACM-systeem (Auto Connect Middle)
Snelle montage dankzij geïntegreerde verbindingen

AutoConnectEnd (ACE)



DETAIL

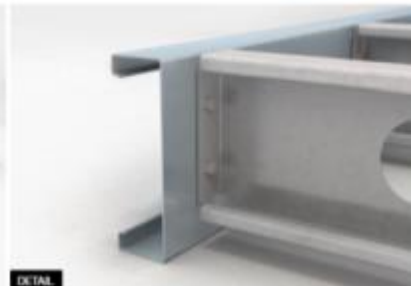

AutoConnectMiddle (ACM) + AutoNotch (AN)



DETAIL

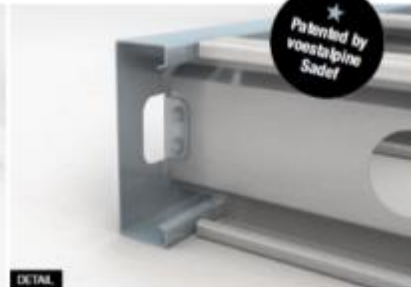

voestalpine Sadef nv

32 | 14/11/2017 | Industrialisatie van de bouw

voestalpine

ONE STEP AHEAD.

RESIDENTIELE BOUW IN RISICOGEBIEDEN

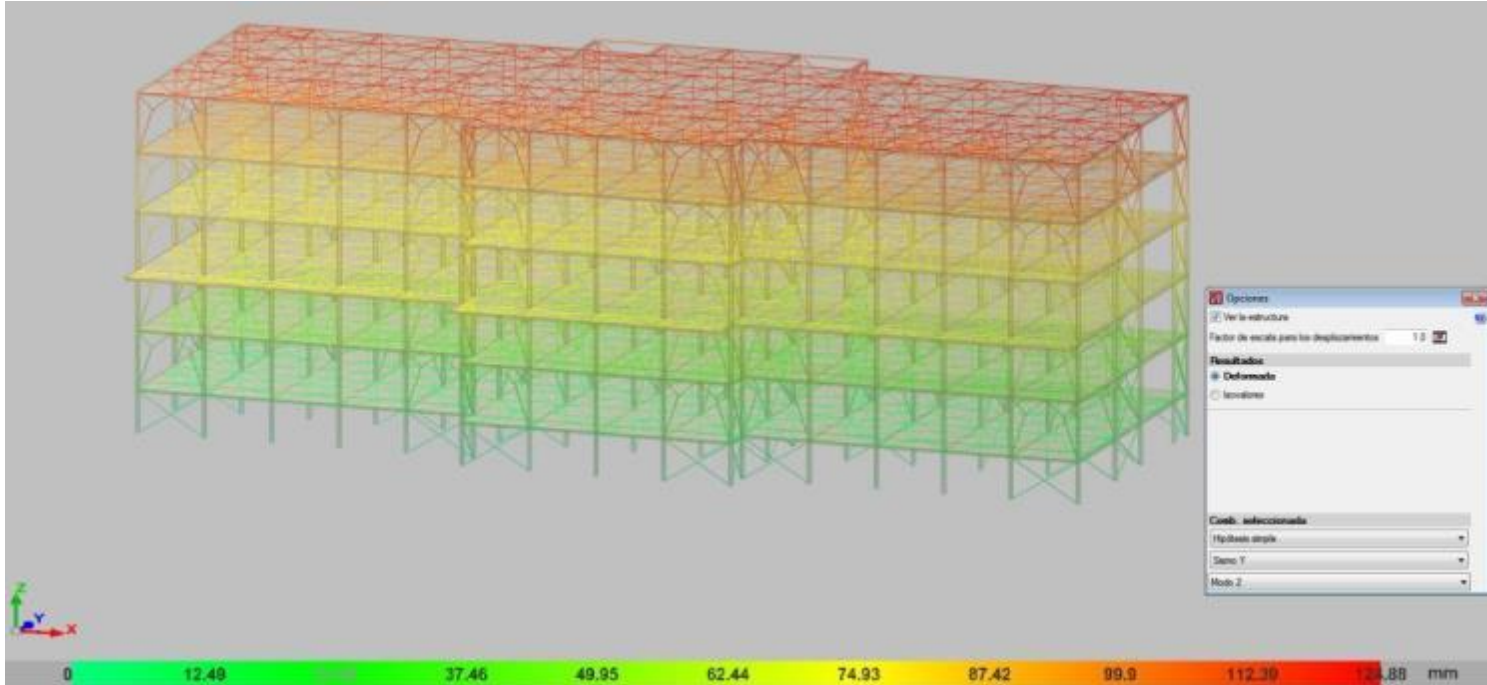

Seismic analysis

RESIDENTIELE BOUW

IN RISICOGEBIEDEN : PROTOTYPING

SADEF
BUILDING PRODUCTS



voestalpine Sadef nv

» Inleiding

» Toepassingen

- » FRAMES VOOR MODULAIRE UNITS
- » RESIDENTIELE BOUW IN RISICOGEBIEDEN
- » HOOGBOUW STOCKAGE

HOOGBOUW



Compacte
appartements
bouw?

If you can
dream it

HOOGBOUW



Is eigenlijk
hoogbouw-
magazijn

Systeembouw
compleet uit
gerolvormde
profielen

HOOGBOUW

SADEF
BUILDING PRODUCTS



Maximale voormontage
op de grond

Zou zelfs met
bekledingsmaterialen
moeten kunnen.

Wind & regendichte
prefab 'units' met grote
afmetingen op elkaar te
stapelen.

HOOGBOUW

SADEF
BUILDING PRODUCTS



.....

voestalpine Sadef nv

39 | 14/11/2017 | Industrialisatie van de bouw

voestalpine
ONE STEP AHEAD.

HOOGBOUW

SADEF
BUILDING PRODUCTS



voestalpine Sadef nv

40 | 14/11/2017 | Industrialisatie van de bouw

voestalpine
ONE STEP AHEAD.

HOOGBOUW

SADEF
BUILDING PRODUCTS



.....

voestalpine Sadef nv

41 | 14/11/2017 | Industrialisatie van de bouw

voestalpine
ONE STEP AHEAD.

HOOGBOUW

SADEF
BUILDING PRODUCTS



voestalpine Sadef nv

42 | 14/11/2017 | Industrialisatie van de bouw

voestalpine
ONE STEP AHEAD.

HOOGBOUW

SADEF
BUILDING PRODUCTS



voestalpine Sadef nv

43 | 14/11/2017 | Industrialisatie van de bouw

voestalpine
ONE STEP AHEAD.

INDUSTRIALISATIE VAN DE BOUW



Industrialisatie leidt ongetwijfeld tot

- Nauwkeuriger fabricatie
- Sneller toeleveren
- Sneller bouwen
- Minder bouwafval
- Duurzaam bouwen
- Financieel voordeel

Uitdaging voor architecten & ingenieursbureau's

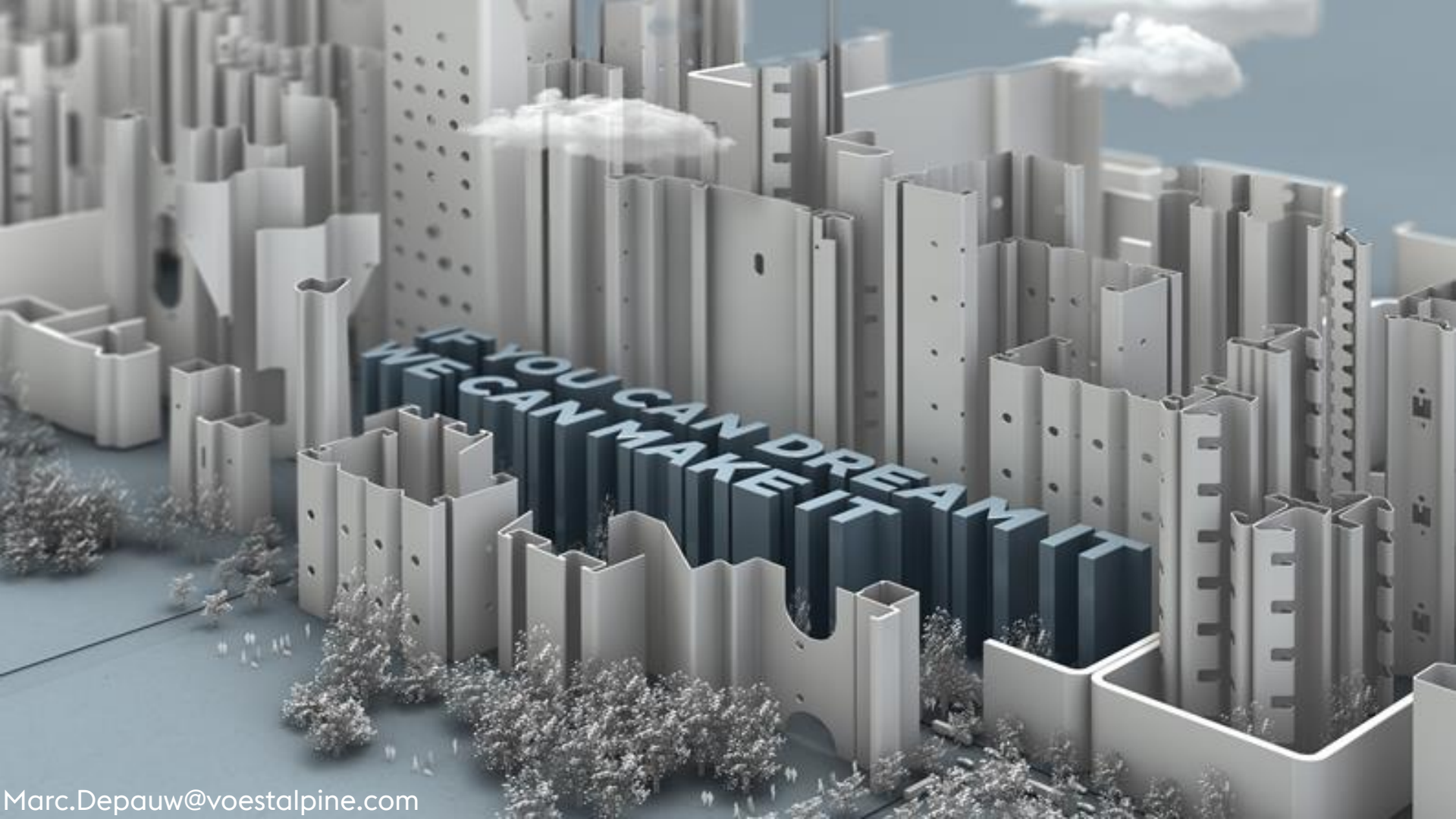

IF YOU CAN DREAM IT
WE CAN MAKE IT